

NK-6121

3.5 inch Bay Trail J1900 Single Board

特点 Feature

- Intel® Celeron® J1900 processor, Quad-core, base frequency 2.0GHz, TDP 10W
- Support 1xDDR3L-1333MHz SO-DIMM slot, up to 8GB
- Support VGA, HDMI, LVDS/eDP Dual-display
- 2xGiga-bit Ethernet
- 1xUSB3.0 port, 5xUSB2.0 ports
- 1xRS232/485, 1xRS232, 4xTTL
- 1 x M.2-2242 and 1 x Mini-PCIe slot with nano-SIM card socket
- 12~24V power input, lockable DC-IN phoenix terminal block

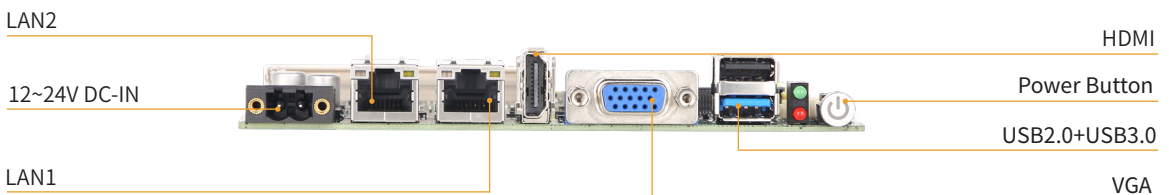
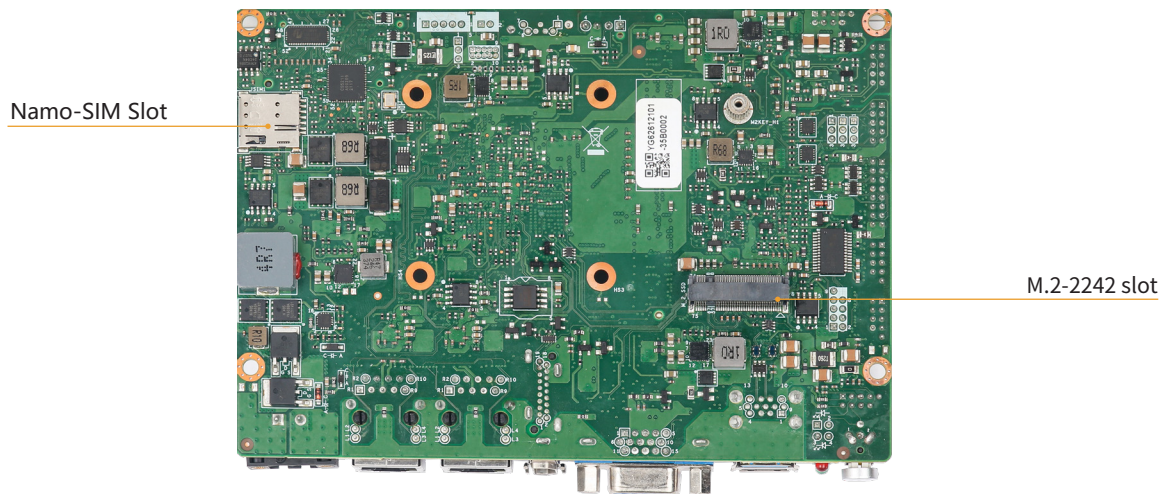
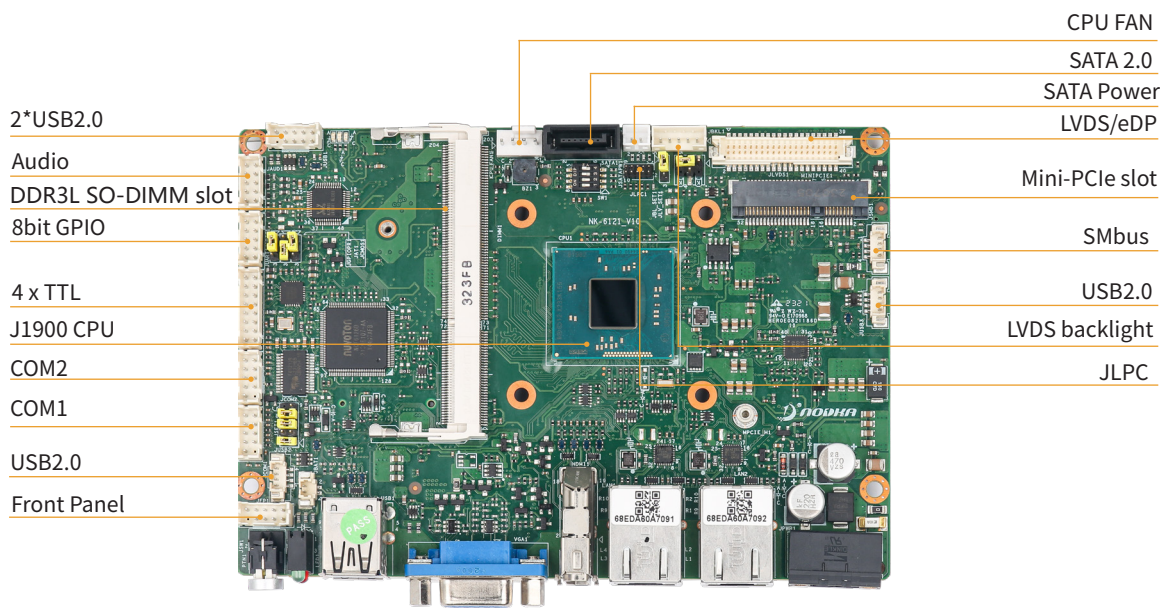

规格 Specification

处理器 Processor System	CPU	Intel® Celeron® J1900 processor 2.0GHz
	芯片组 Chipset	Intel® SoC integrated
	BIOS	AMI 64Mb UEFI BIOS
内存 Memory	技术 Technology	Single Channel(Non-ECC) DDR3L-1333MHz, up to 8GB
	插槽 Slot	1 x DDR3L 240-pin SO-DIMM slot
存储 Storage	SATA	1 x SATA2.0 port
	M.2	1 x M.2-2242 M Key SSD slot(SATA2.0)
图形 Graphic	控制器 Controller	Intel HD graphics integrated
音频 Audio	编码器 Codec	Realtek ALC897 codec
外部接口 Rear I/O	显示 Display	1 x VGA, resolution up to 2560x1600@60Hz 1 x HDMI, resolution to 1920x1080@60Hz
	网络 Ethernet	2 x GbE(RJ45), Realtek 8111H controller
	USB	1 x USB3.0(5Gbps), 1 x USB2.0(480Mbps)
	开关按键 Button	1 x Power Button(White for power on,Blink for sleep mode,Off for power off)
	指示灯 Indicators	1 x SATA LED(Red), 1 x Power LED(Green)
内部接口 Internal I/O	显示 Display	1 x LVDS, dual channel 18/24bit, resolution up to 1920x1200@60Hz 1 x eDP1.3, max resolution up to 3840x2160@60Hz(share connector with LVDS)
	音频 Audio	1 x Audio wafer(Mic-in/Line-out, 2*5pin)
	USB	2 x USB2.0 wafer(1*4pin), 2 x USB2.0 wafer(1 x 2*5pin)
	串口 Serial Port	1 x RS232/RS485 wafer(2*5pin), 1 x RS232 wafer(2*5pin),4 x TTL wafer(2*8pin)
	风扇 Fan	1 x Smart Fan wafer(1*4pin)
	SMbus	1 x SMbus wafer(1*4pin)
	LPC	1 x LPC header for debug
	GPIO	1 x 8bit GPIO(2*5pin)
	其他 Others	1 x Front panel wafer(2*5pin)(Power LED, HDD LED, Power button, Reset button)
扩展接口 Expansion Slots	Mini-PCIe slot	1 x Mini-PCIe slot with Nano-SIM socket(PCIe/USB2.0)
看门狗定时器 Watchdog Timer	输出 & 间隔 Output&Interval	System reset, programmable from 1~255 seconds
电源 Power	类型 Type	12~24V DC input, +/-10% tolerance
	接口 Interface	1 x 2-pin phoenix terminal block
	功耗 Power Consumption	16.3W(Idle mode), 17.5W(Typical mode)
操作系统 O.S Support	MS Windows	Windows7/10
	Linux	Linux
机械参数 Mechanism	尺寸 Dimensions	(L)146mm x (W)102mm
	净重 Gross Weight	0.165kg
环境 Environment	温度 Temperature	Operating: -10°C ~60°C with SSD Storage: -40°C ~85°C
	湿度 Humidity	5~95% (Non-condensing)
	振动 Vibration	5~500Hz,3Grms operating

框架图 Block Diagram

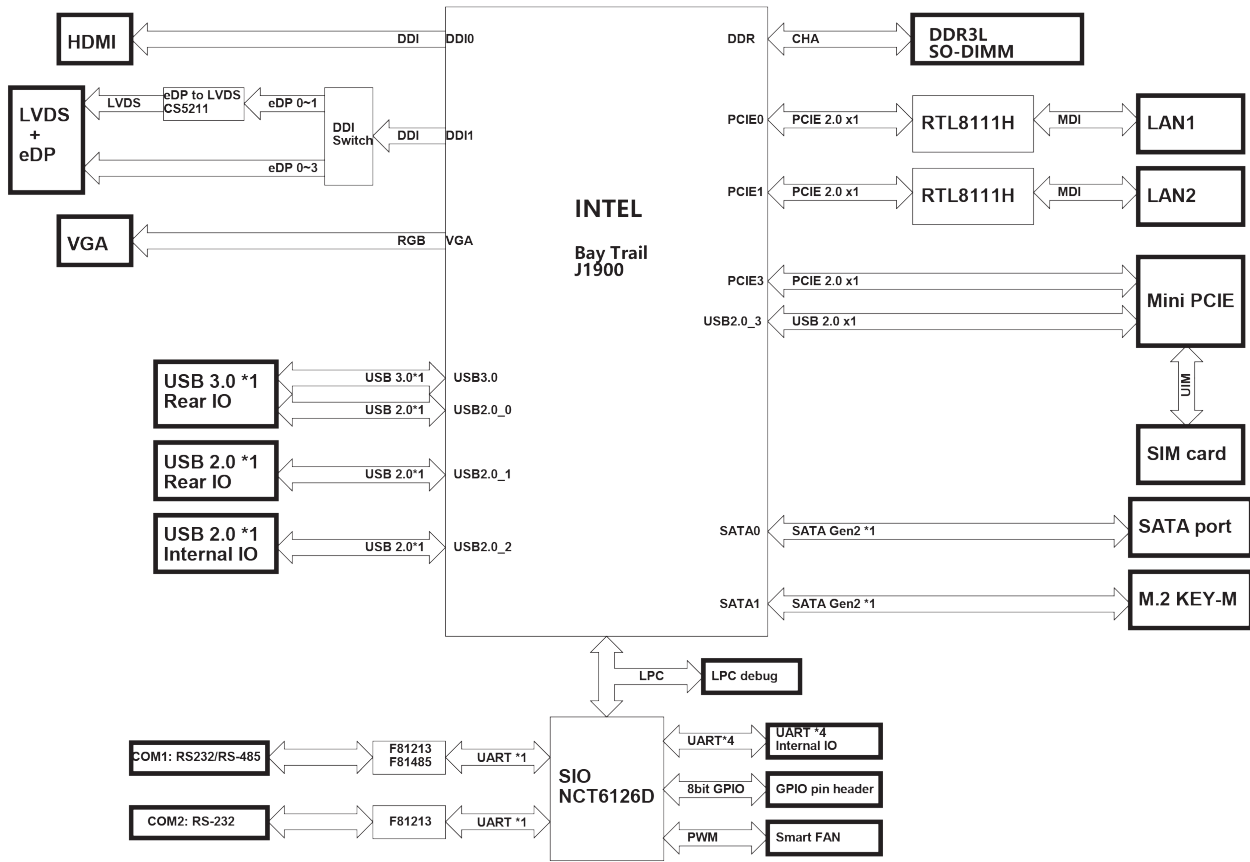

机构图 Mechanical Drawing

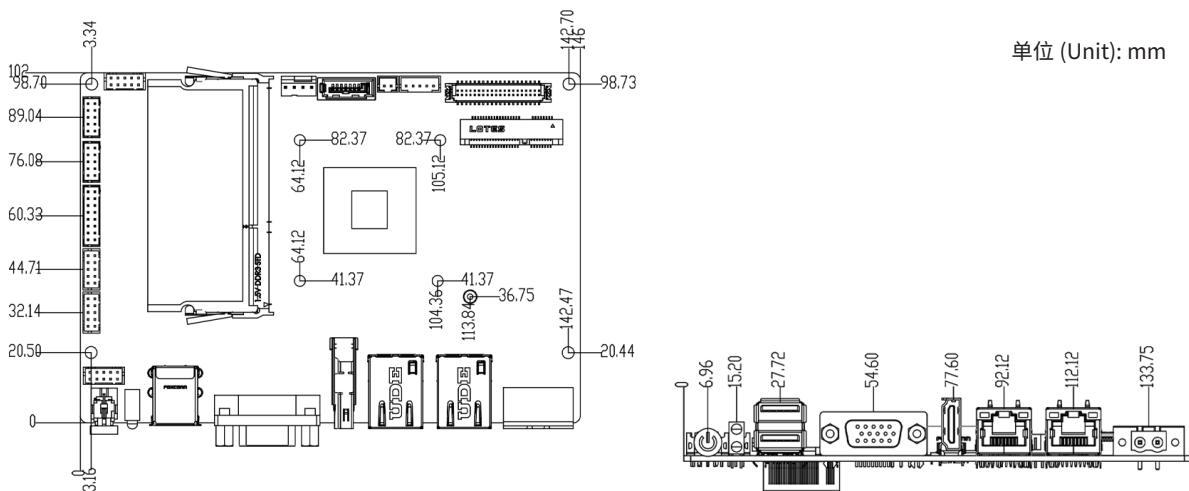

订购信息 Order Information

料号 Part No.	型号 Model	描述 Description
F32.612103.10.NEK	NK-6121	3.5", Baytrial, J1900, DDR3L SO-DIMM, M.2-2242(SATA2.0), Standard, compose, 2*COM Cable, 1*SATA Cable, w/ALC897,w/210AT

包装清单 Packing List

料号 Part No.	数量 Qty	描述 Description
KF0.001046.00.L54	2	COM Cable,2*5pin wafer to DB9 cable, length=150mm
KF0.001049.00.L54	1	SATA Cable,signal and power cable
JF7.000041.00.D03	1	2-pin termianl block,pitch 5.08mm

可选配件 Optional Accessories

料号 Part No.	描述 Description
L45.000019.00.M42	Heatsink for NK-6121
C3Z.NKEB01.10.NDJ	AEB-4COM00, 2 x RS485/422/232(DB9) ,2 x RS232 wafer I/O expansion kit
C3Z.0001.00.NDJ	CM-060W-CWT0, 12V/60W adapter, 180cm power cord
C3Z.0002.00.NDJ	CM-090W-HKA, 12V/84W adapter, 180cm power cord
KF0.001046.00.L54	COM Cable,2*5pin wafer to DB9 cable, length=150mm
KF0.001047.00.L54	USB cable, 1*4pin wafer to USB2.0 type-A cable, length=150mm
KF0.001048.00.L54	USB cable, 2 x USB2.0 type-A Y cable with bracket, length=150mm
KF0.000949.00.Y09	Audio Cable, 2*5pin wafer to Mic-in/Line-out cable, length=300mm